



## INSTRUCTION MANUAL

VHF MARINE TRANSCEIVER

# IC-M37 IC-M37E

This device complies with Part 15 of the FCC rules. Operation is subject to the conditions that this device does not cause harmful interference.



Icom Inc.

Thank you for choosing this Icom product. This product was designed and built with Icom's state of the art technology and craftsmanship. With proper care, this product should provide you with years of trouble-free operation.

## ■ IMPORTANT

**READ ALL INSTRUCTIONS** carefully and completely before using the transceiver.

**SAVE THIS INSTRUCTION MANUAL** — This instruction manual contains important operating instructions for the IC-M37/IC-M37E.

## ■ EXPLICIT DEFINITIONS

WORD	DEFINITION
⚠ <b>DANGER!</b>	Personal death, serious injury or an explosion may occur.
⚠ <b>WARNING!</b>	Personal injury, fire hazard or electric shock may occur.
<b>CAUTION</b>	Equipment damage may occur.
<b>NOTE</b>	If disregarded, inconvenience only. No risk of personal injury, fire or electric shock.

## ■ FEATURES

- 6 W\*1 RF output power
- Powerful 700 mW audio output for clear communication
- Float'n Flash:  
Floats and flashes on the water
- IP57\*2 dust protection and waterproof construction
  - \*1 5 W for the AUS version.
  - \*2 Only when the supplied battery pack or case, antenna, and jack cover are attached.

## ■ IN CASE OF EMERGENCY

If your vessel requires assistance, contact other vessels and the Coast Guard by sending a distress call on Channel 16.

### ◇ USING CHANNEL 16

1. Push [16/C] to switch to Channel 16.
2. While holding down [PTT], give the appropriate information as follows:

- "MAYDAY MAYDAY MAYDAY."
- "THIS IS "  
(name of vessel).
- Say your call sign or other indication of the vessel (AND your 9 digit DSC ID, if you have one).
- "LOCATED AT "  
(your position).
- State the nature of the distress and assistance required.
- Give any other information which might facilitate the rescue.

## ■ RECOMMENDATION

**CLEAN THE TRANSCEIVER AND MICROPHONE THOROUGHLY WITH FRESH WATER** after exposure to

saltwater, and dry it before operating. Otherwise, the transceiver's keys, switches and controllers may become unusable, due to salt crystallization.

**NOTE:** If the transceiver's waterproof protection appears defective, carefully clean it with a soft, wet (fresh water) cloth, then, dry it before operating. The transceiver may lose its waterproof protection if the case or microphone is cracked or broken, the microphone connector is not screwed in completely, or the transceiver has been dropped. Contact your Icom distributor or your dealer for advice.

## ■ FCC INFORMATION

This equipment has been tested and found to comply with the limits for a Class A digital device, pursuant to part 15 of the FCC Rules. These limits are designed to provide reasonable protection against harmful interference when the equipment is operated in a commercial environment. This equipment generates, uses, and can radiate radio frequency energy and, if not installed and used in accordance with the instruction manual, may cause harmful interference to radio communications. Operation of this equipment in a residential area is likely to cause harmful interference in which case the user will be required to correct the interference at his own expense.

**CAUTION:** Changes or modifications to this transceiver, not expressly approved by Icom Inc., could void your authority to operate this transceiver under FCC regulations.

## ■ INFORMATION FCC

Cet équipement a été testé et reconnu conforme aux limites fixées pour un appareil numérique de classe A, conformément au point 15 de la réglementation FCC. Ces limites sont définies de façon à fournir une protection raisonnable contre le brouillage préjudiciable lorsque cet appareil est utilisé dans un environnement commercial. Cet équipement génère, utilise et peut émettre un rayonnement de fréquence radio. S'il n'a pas été installé conformément aux instructions, il peut par ailleurs créer des interférences perturbant les communications radio. L'utilisation de cet appareil dans une zone résidentielle peut provoquer un brouillage préjudiciable, auquel cas l'utilisateur sera tenu de corriger la situation à ses frais.

**MISE EN GARDE:** Tout changement ou modification, non expressément approuvé par Icom Inc., peut annuler l'autorisation de l'utilisateur à utiliser cet appareil conformément à la réglementation FCC.

## ■ ABOUT CE AND DOC



Hereby, Icom Inc. declares that the versions of IC-M37E which have the "CE" symbol on the product, comply with the essential requirements of the Radio Equipment Directive, 2014/53/EU, and the restriction of the use of certain hazardous substances in electrical and electronic equipment Directive, 2011/65/EU. The full text of the EU declaration of conformity is available at the following internet address:

<http://www.icom.co.jp/world/support/>

## ■ DISPOSAL



The crossed-out wheeled-bin symbol on your product, literature, or packaging reminds you that in the European Union, all electrical and electronic products, batteries, and accumulators (rechargeable batteries) must be taken to designated collection locations at the end of their working life. Do not dispose of these products as unsorted municipal waste. Dispose of them according to the laws in your area.

---

# ■ TABLE OF CONTENTS

■ IMPORTANT .....	i	7	<b>DUALWATCH AND TRI-WATCH</b>		
■ EXPLICIT DEFINITIONS .....	i		<b>(Except the HOL version) .....</b>	<b>16</b>	
■ FEATURES .....	i		■ Description .....	16	
■ IN CASE OF EMERGENCY.....	i		■ Operation .....	16	
■ RECOMMENDATION .....	i	8	<b>SET MODE.....</b>	<b>17</b>	
■ FCC INFORMATION.....	ii		■ Using the Set mode.....	17	
■ INFORMATION FCC.....	ii		■ Set mode items .....	18	
■ ABOUT CE AND DOC .....	ii	9	<b>ATIS CODE</b>		
■ DISPOSAL .....	ii		<b>(For only the HOL and FRG versions)</b>		
■ PRECAUTIONS .....	iv		.....	<b>20</b>	
■ PRÉCAUTIONS .....	v	10	<b>SPECIFICATIONS AND OPTIONS..</b>	<b>21</b>	
■ SAFETY TRAINING INFORMATION	vi		■ Specifications .....	21	
.....	vi		■ Options.....	22	
■ INFORMATION EN MATIÈRE DE			■ Using the BP-297 .....	22	
SÉCURITÉ .....	vii		■ Using the HM-213 .....	23	
1	<b>OPERATING RULES .....</b>	<b>1</b>	11	<b>VHF MARINE CHANNEL LIST.....</b>	<b>24</b>
2	<b>ACCESSORIES .....</b>	<b>2</b>		■ For IC-M37 (USA and EXP) and IC-	
	■ Supplied accessories .....	2		M37E (AUS) .....	24
	■ Attaching accessories .....	2		■ For IC-M37E (Except AUS).....	25
3	<b>PANEL DESCRIPTION .....</b>	<b>4</b>	12	<b>TROUBLESHOOTING.....</b>	<b>26</b>
	■ Front, top and side panels.....	4		INDEX.....	27
	■ Function Display.....	5			
4	<b>BATTERY CHARGING .....</b>	<b>6</b>			
	■ Battery caution .....	6			
	■ Charging caution .....	7			
	■ Battery charger.....	8			
5	<b>BASIC OPERATION .....</b>	<b>9</b>			
	■ Selecting a channel.....	9			
	■ Weather channels and Weather Alert				
	(For the USA, EXP, and AUS				
	versions).....	10			
	■ Receiving and transmitting.....	11			
	■ Adjusting the squelch level.....	12			
	■ Volume Loud/Mute function.....	12			
	■ Monitor function.....	12			
	■ AquaQuake Water Draining function				
	.....	12			
	■ Setting the Call channel .....	13			
	■ Power OFF Subfunction.....	13			
	■ CH History function .....	13			
6	<b>SCAN OPERATION .....</b>	<b>14</b>			
	■ Favorite channels.....	15			
	■ Starting a scan				
	(Except the HOL version) .....	15			

---

## ■ PRECAUTIONS

⚠ **WARNING! NEVER** use or charge Icom battery packs with non-Icom transceivers or non-Icom chargers. Only Icom battery packs are tested and approved for use with Icom transceivers or charged with Icom chargers. Using third-party or counterfeit battery packs or chargers may cause smoke, fire, or cause the battery to burst.

⚠ **WARNING! NEVER** hold the transceiver so that the antenna is very close to, or touching exposed parts of the body, especially the face or eyes, while transmitting.

⚠ **WARNING! NEVER** operate the transceiver with a headset or other audio accessories at high volume levels. The continuous high volume operation may cause a ringing in your ears. If you experience the ringing, reduce the volume level or discontinue use.

**CAUTION: DO NOT** short the terminals of the battery pack. Shorting may occur if the terminals touch metal objects such as a key, so be careful when placing the battery packs (or the transceiver) in bags, and so on. Carry them so that shorting cannot occur with metal objects. Shorting may damage not only the battery pack, but also the transceiver.

**CAUTION: DO NOT** use harsh solvents such as Benzine or alcohol when cleaning. This could damage the equipment surfaces. If the surface becomes dusty or dirty, wipe it clean with a soft, dry cloth.

**CAUTION: DO NOT** place or leave the transceiver in excessively dusty environments. This could damage the transceiver.

**NOTE: DO NOT** place or leave the transceiver in direct sunlight or in areas outside of the specified temperature range:  
IC-M37:  $-20^{\circ}\text{C}$  ( $-4^{\circ}\text{F}$ )  $\sim$   $+60^{\circ}\text{C}$  ( $+140^{\circ}\text{F}$ )  
IC-M37E:  $-15^{\circ}\text{C}$  ( $5^{\circ}\text{F}$ )  $\sim$   $+55^{\circ}\text{C}$  ( $131^{\circ}\text{F}$ )  
IC-M37E (AUS):  
 $-10^{\circ}\text{C}$  ( $14^{\circ}\text{F}$ )  $\sim$   $+55^{\circ}\text{C}$  ( $131^{\circ}\text{F}$ )

Keep the transceiver in a secure place to prevent use by unauthorized persons.

**BE CAREFUL!** The transceiver meets IP57 requirements for dust protection and waterproof protection. However, once the transceiver has been dropped, dust protection and waterproof protection cannot be guaranteed due to the fact that the transceiver may be cracked, or the waterproof seal damaged, and so on.

\* Only when the supplied battery pack or case, antenna, and jack cover are attached.

### Information:

In this instruction manual, the transceiver version names are described as shown below.

U.S.A.: USA    Export: EXP    Europe: EUR  
German: FRG    Dutch: HOL    U.K.: UK  
Australia: AUS

Icom is not responsible for the destruction, damage to, or performance of any Icom or non-Icom equipment, if the malfunction is because of:

- Force majeure, including, but not limited to, fires, earthquakes, storms, floods, lightning, other natural disasters, disturbances, riots, war, or radioactive contamination.
- The use of Icom transceivers with any equipment that is not manufactured or approved by Icom.

Icom, Icom Inc. and the Icom logo are registered trademarks of Icom Incorporated (Japan) in Japan, the United States, the United Kingdom, Germany, France, Spain, Russia, Australia, New Zealand, and/or other countries.

AquaQuake is a trademark of Icom Incorporated.

All other products or brands are registered trademarks or trademarks of their respective holders.

---

## ■ PRÉCAUTIONS

⚠ **AVERTISSEMENT !** N'utilisez JAMAIS et ne rechargez JAMAIS des blocsbatteries Icom avec des émetteurs-récepteurs non-Icom ou des chargeurs non-Icom. Seuls les blocsbatteries Icom sont testés et homologués pour être utilisés avec des émetteurs-récepteurs Icom ou pour être rechargés avec des chargeurs Icom. L'utilisation de blocsbatteries ou de chargeurs tiers ou de contrefaçon peut être à l'origine de fumées, d'incendie ou peut faire éclater la batterie.

⚠ **AVERTISSEMENT ! NE JAMAIS** l'émetteur-récepteur de sorte que l'antenne soit très proche des parties exposées du corps, en particulier du visage ou des yeux, et ne les touche pas pendant la transmission.

⚠ **AVERTISSEMENT !** N'utilisez JAMAIS l'émetteur-récepteur avec un casque ou d'autres accessoires audio à des niveaux de volume élevés. Le fonctionnement continu à volume élevé peut provoquer une sonnerie dans vos oreilles. Si vous ressentez la sonnerie, réduisez le volume ou cessez d'utiliser.

**MISE EN GARDE : NE PAS** court-circuiter les bornes de la batterie. Un court-circuit peut se produire si les bornes touchent des objets métalliques tels qu'une clé. Soyez donc prudent lorsque vous placez les batteries (ou l'émetteur-récepteur) dans des sacs, etc. Transportez-les de manière à ce qu'il n'y ait pas de court-circuit avec des objets métalliques. Un court-circuit peut endommager non seulement la batterie, mais également l'émetteur-récepteur.

**MISE EN GARDE : NE PAS** utiliser de dissolvants agressifs tels que du Benzène ou de l'alcool lors du nettoyage, car ils endommageraient les surfaces de l'émetteur-récepteur. Si l'émetteur-récepteur est poussiéreux ou sale, nettoyez-le avec un tissu doux et sec.

**MISE EN GARDE : NE PAS** placer l'émetteur-récepteur dans des environnements excessivement poussiéreux. Cela pourrait endommager l'émetteur-récepteur.

**REMARQUE : NE PAS** placer ou laisser l'émetteur-récepteur en plein soleil ou dans un environnement soumis à des températures inférieures à  $-20^{\circ}\text{C}$  ( $-4^{\circ}\text{F}$ ) ou supérieures à  $+60^{\circ}\text{C}$  ( $+140^{\circ}\text{F}$ ). Placez l'émetteur-récepteur dans un lieu sûr pour éviter toute utilisation par des personnes non autorisées.

**MISE EN GARDE :** Cet émetteur-récepteur répond aux exigences de la norme IP57 en matière de protection contre la poussière et de protection étanche. Cependant, en cas de chute de l'émetteur-récepteur, la protection contre la poussière et la protection étanche ne peuvent plus être garanties, car le boîtier risque d'être fissuré ou le joint d'étanchéité endommagé, etc.

\* Uniquement lorsque la batterie ou le boîtier, l'antenne et le cache-prise sont fixés.

## ■ SAFETY TRAINING INFORMATION



Your Icom radio generates RF electromagnetic energy while transmitting. This radio is designed for and classified as for “Occupational Use Only.” This means it must be used only during the course of employment by individuals aware of the hazards, and the ways to minimize such hazards. This radio is NOT intended for use by the “General Population” in an uncontrolled environment. This radio has been tested and complies with the FCC and IC RF exposure limits for “Occupational Use Only”. In addition, your Icom radio complies with the following Standards and Guidelines with regard to RF energy and electromagnetic energy levels and evaluation of such levels for exposure to humans:

- FCC KDB Publication 447498 D03, Evaluating Compliance with FCC Guidelines for Human Exposure to Radio Frequency Electromagnetic Fields.
- American National Standards Institute (C95.1-1992), IEEE Standard for Safety Levels with Respect to Human Exposure to Radio Frequency Electromagnetic Fields, 3 kHz to 300 GHz.
- American National Standards Institute (C95.3-1992), IEEE Recommended Practice for the Measurement of Potentially Hazardous Electromagnetic Fields— RF and Microwave.
- The accessories listed on page i are authorized for use with this product. Use of accessories other than those specified may result in RF exposure levels exceeding the FCC requirements for wireless RF exposure.
- Health Canada Safety Code 6 - Limits of Human Exposure to Electromagnetic Energy in the Frequency Range from 3 kHz to 300 GHz.



To ensure that your exposure to RF electromagnetic energy is within the FCC allowable limits for occupational use, always adhere to the following guidelines:

- **DO NOT** operate the radio without a proper antenna attached, as this may damage the radio and may also cause you to exceed FCC RF exposure limits. A proper antenna is the antenna supplied with this radio by the manufacturer or an antenna specifically authorized by the manufacturer for use with this radio.
- **DO NOT** transmit for more than 50% of the total radio use time (“50% duty cycle”). Transmitting more than 50% of the time can cause FCC RF exposure compliance requirements to be exceeded. The radio is transmitting when “TX” is displayed on the function display. You can cause the radio to transmit by pushing the [PTT] switch.
- **ALWAYS keep** the antenna at least 2.5 cm (1 inch) away from the body when transmitting and only use the Icom belt-clips which are listed on page 12 when attaching the radio to your belt, or other place, to ensure FCC and IC RF exposure compliance requirements are not exceeded.

The information listed above provides the user with the information needed to make him or her aware of RF exposure, and what to do to assure that this radio operates within the FCC RF exposure limits of this radio.

### **Electromagnetic Interference/ Compatibility**

During transmissions, your Icom radio generates RF energy that can possibly cause interference with other devices or systems. To avoid such interference, turn off the radio in areas where signs are posted to do so. DO NOT operate the transmitter in areas that are sensitive to electromagnetic radiation such as hospitals and blasting sites.

### **Occupational/Controlled Use**

The radio transmitter is used in situations in which persons are exposed as consequence of their employment provided those persons are fully aware of the potential for exposure and can exercise control over their exposure.

## ■ INFOMATION EN MATIÈRE DE SÉCURITÉ



AVERTISSEMENT

Votre radio Icom produit une énergie électromagnétique de radiofréquences (RF), en mode de transmission. Cette radio est conçue pour un «usage professionnel seulement» et classée comme tel, ce qui signifie qu'elle doit être utilisée uniquement dans le cadre d'un travail par des personnes conscientes des dangers et des mesures visant à minimiser ces dangers. Elle N'EST PAS conçue pour une «utilisation grand public», dans un environnement non contrôlé. Cet appareil a été évalué et jugé conforme, aux limites d'exposition aux RF de la FCC et d'IC, pour une «utilisation grand public». En outre, votre radio Icom satisfait les normes et directives qui suivent en matière de niveaux d'énergie et d'énergie électromagnétique de RF et d'évaluation de tels niveaux en ce qui concerne l'exposition humaine:

- Publication 447498 D03 de la FCC KDB, «Evaluating Compliance with FCC Guidelines for Human Exposure to Radio Frequency Electromagnetic Fields».
- Norme de l'American National Standards Institute (ANSI): IEEE C95.1-1992 sur les niveaux de sécurité compatibles avec l'exposition humaine aux champs électromagnétiques de radiofréquences (3 kHz à 300 GHz).
- Norme de l'ANSI: IEEE C95.3-1992 sur la méthode d'évaluation recommandée du champ magnétique potentiellement dangereux des radiofréquences et des micro-ondes.
- Les accessoires illustrés dans "Options" de la feuille d'instructions sont approuvés pour une utilisation avec ce produit. L'utilisation d'accessoires autres que ceux précisés peut entraîner des niveaux d'exposition aux RF supérieures aux limites établies par la FCC et d'IC en matière d'exposition aux RF sans fil.
- Le Code de sécurité 6 de Santé Canada - Les limites d'exposition humaine à l'énergie électromagnétique dans la gamme de fréquences de 3 kHz à 300 GHz.

Afin de vous assurer que votre exposition à une énergie électromagnétique de RF se situe dans les limites permises par la FCC pour une utilisation grand public, veuillez en tout temps respecter les directives suivantes :



MISE EN GARDE

- **NE PAS** faire fonctionner la radio sans qu'une antenne appropriée y soit fixée, car ceci risque d'endommager la radio et causer une exposition supérieure aux limites établies par la FCC. L'antenne appropriée est celle qui est fournie avec cette radio par le fabricant ou une antenne spécialement autorisée par le fabricant pour être utilisée avec cette radio.
- **NE PAS** émettre pendant plus de 50% du temps total d'utilisation de l'appareil («50% du facteur d'utilisation»). Émettre pendant plus de 50% du temps total d'utilisation peut causer une exposition aux RF supérieure aux limites établies par la FCC. La radio est en train d'émettre lorsque le témoin du "TX" s'affiche sur l'écran ACL. La radio émettra si vous appuyez sur le bouton du microphone.
- **TOUJOURS tenir** l'antenne éloignée d'au moins 2,5 cm de votre corps au moment d'émettre et utiliser uniquement l'attache pour ceinture Icom illustrée à la p. 12, lorsque vous attachez la radio à votre ceinture, ou à autre chose, de façon à vous assurer de ne pas provoquer une exposition aux RF supérieure aux limites fixées par la FCC. Pour offrir à vos interlocuteurs la meilleure qualité de transmission possible, tenez l'antenne à au moins 5 cm de votre bouche et légèrement de côté.

Les renseignements ci-dessus fournissent à l'utilisateur toute l'information nécessaire sur l'exposition aux RF et sur ce qu'il faut faire pour assurer que cette radio fonctionne en respectant les limites d'exposition aux RF établies par la FCC.

### **Interférence électromagnétique et compatibilité**

En mode de transmission, votre radio Icom produit de l'énergie de RF qui peut provoquer des interférences avec d'autres appareils ou systèmes. Pour éviter de telles interférences, mettez la radio hors tension dans les secteurs où une signalisation l'exige. **NE PAS** faire fonctionner l'émetteur dans des secteurs sensibles au rayonnement électromagnétique tels que les hôpitaux, les aéronefs et les sites de dynamitage.

### **Usage professionnel/contrôlé**

Ce radio émetteur est utilisé dans des cas où des personnes sont exposées en raison de leur travail, pourvu qu'elles soient conscientes du risque d'exposition et qu'elles puissent exercer un contrôle sur cette exposition.



## ◇ Priorities

- Read all rules and regulations pertaining to priorities and keep an up-to-date copy handy. Safety and distress calls take priority over all others.
- You must monitor Channel 16 when you are not operating on another channel.
- False or fraudulent distress calls are prohibited under law.

## ◇ Privacy

- Information overheard but not intended for you cannot lawfully be used in any way.
- Indecent or profane language is prohibited.

## ◇ Radio licenses

### (1) SHIP STATION LICENSE

You must have a current radio station license before using the transceiver. It is unlawful to operate a ship station which is not licensed.

Inquire through your dealer or the appropriate government agency for a Ship-Radiotelephone license application. This government-issued license states the call sign which is your craft's identification for radio purposes.

### (2) OPERATOR'S LICENSE

A Restricted Radiotelephone Operator Permit is the license most often held by small vessel radio operators when a radio is not required for safety purposes.

The Restricted Radiotelephone Operator Permit must be posted or kept with the operator. Only a licensed radio operator may operate a transceiver.

However, non-licensed individuals may talk over a transceiver if a licensed operator starts, supervises, ends the call and makes the necessary log entries.

A current copy of the applicable government rules and regulations is only required to be on hand for vessels in which a radio telephone is compulsory. However, even if you are not required to have these on hand it is your responsibility to be thoroughly acquainted with all pertinent rules and regulations.

**NOTE:** Even though the IC-M37/IC-M37E is capable of operation on VHF marine channels 21, 23, 81, 82, and 83, according to FCC regulations these simplex channels cannot be lawfully used by the general population in USA waters.

## ■ Supplied accessories

Antenna

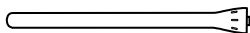

Handstrap



Belt clip

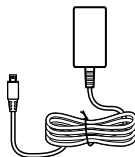
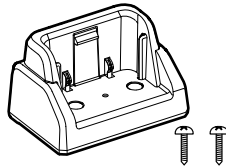

Battery pack

Power adapter  
(For Desktop charger)Desktop charger  
(With two screws)

**NOTE:** Some accessories are not supplied, or the shape is different, depending on the transceiver version.

## ■ Attaching accessories

### ◇ Antenna

Connect the supplied antenna to the antenna connector.

#### CAUTION:

- **DO NOT** carry the transceiver by holding only the antenna.
- **DO NOT** connect an antenna other than those listed in this instruction manual.
- **DO NOT** transmit without an antenna.

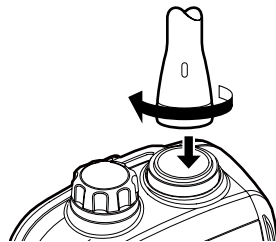

### ◇ Belt clip

#### To attach:

Slide the belt clip in the direction of the arrow until the belt clip is locked and makes a 'click' sound.

#### To detach:

Lift the tab up (❶), and slide the belt clip in the direction of the arrow (❷).

**BE CAREFUL! DO NOT** break your fingernail.

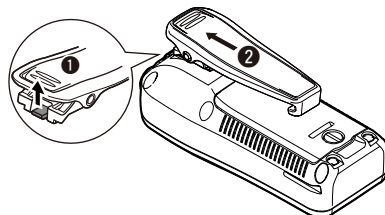
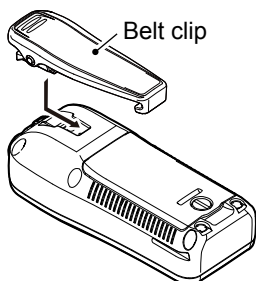

## ◇ Battery pack

### To insert:

1. Use a coin or standard screwdriver (❶), and turn the screw counter clockwise one quarter turn (❷).

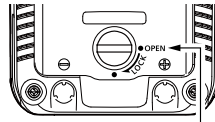
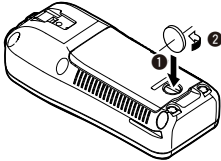

Screw position when removing the battery cover.

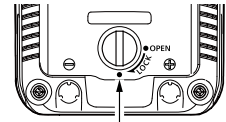

Screw position when attaching the battery cover.

2. Open the battery cover (❶), and place the battery pack into the transceiver so it fits flat (❷).
3. Securely attach the battery cover.

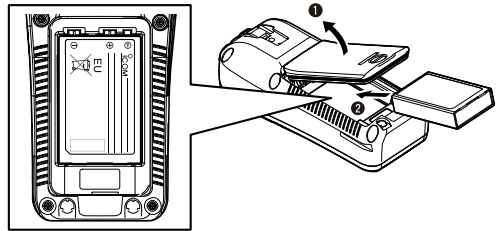

### To remove:

Slide the latch and then lift the battery cover to remove it. Then remove the battery pack.

### CAUTION:

- **NEVER** remove the battery cover when the transceiver is wet or soiled. This may result in water or dust getting into the transceiver/battery pack, and may result in the transceiver being damaged.
- When attaching or removing the battery cover, make sure the rubber seal is correctly set in the groove of the cover. If the seal is not correctly in the groove, it may be damaged when attaching the battery cover. If the seal is damaged, waterproof protection is not guaranteed.
- When attaching the battery cover, make sure dust or other material does not adhere to the rubber seal. If dust or other material is on the seal when attaching the battery cover, waterproof protection may not be guaranteed.

Make sure the rubber seal is properly seated in the groove and there is dust or other material is on it.

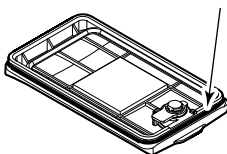

### Correct position

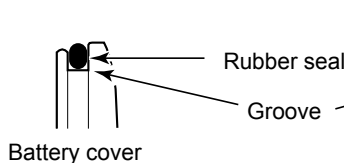

### Incorrect position

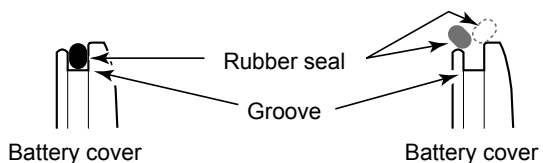

## ■ Front, top and side panels

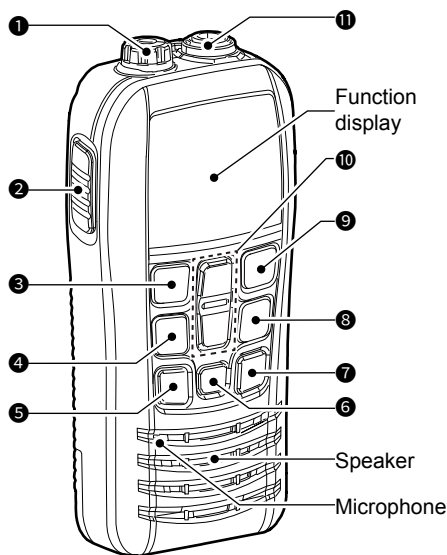

### 1 SPEAKER/MIC JACK [SP/MIC]

(p. 23)

Connect the optional HM-213 speaker microphone here.

### 2 PTT SWITCH [PTT]

Hold down to transmit, release to receive.

### 3 CHANNEL 16/CALL CHANNEL KEY [16/C] (p. 9)

- Push to select Channel 16.
- Hold down for 1 second to select the Call channel.

### 4 VOLUME/SQUELCH/MONITOR KEY [VOL/SQL]/[MONI]

- Push once to display the volume level setting screen.
- Push twice to display the squelch level setting screen. (p. 12)
- Hold down for 1 second to turn ON the monitor function.

### 5 SCAN/DUAL KEY [SCAN]/[DUAL]

- Push to start or stop a scan. (p. 15)
- Hold down for 1 second to start the Dual/Tri-watch mode. (p. 16)
  - ① While in Dualwatch, push to cancel Dualwatch.
  - ① Tri-watch may start, depending on the Set mode settings.
- Hold down both [SCAN] and [Hi/Lo] for 1 second to turn ON the AquaQuake function. (p. 12)

### 6 POWER KEY [P]

Hold down for 1 second to turn the transceiver ON or OFF.

### 7 TRANSMIT POWER/LOCK KEY [Hi/Lo]/[P-O]

- Push to set the power level to High or Low.
  - ① Some channels are set to only Low power.
- Hold down for 1 second to lock or unlock the keypad.

### 8 CHANNEL/WEATHER CHANNEL\*1 KEY [CH/WX]/[U/I/C] or [CH]

- Push to switch between a regular channel and weather channel.\*1 (p. 10)
- Push to select a regular channel.\*2
- Hold down for 1 second to change the channel group. (p. 9)

**NOTE:** [CH] is described as [CH/WX] or [U/I/C] in this instruction manual.

### 9 FAVORITE CHANNEL KEY [FAV] (p. 15)

- Push to select a Favorite channel.
- Hold down for 1 second to set or clear the selected channel as a Favorite channel.

### 10 UP/DOWN KEYS [▲]/[▼]

- Push to select the operating channel.
- Push to change the volume/squelch level while adjusting.
- In the Set mode, push to select an item option.

### 11 ANTENNA CONNECTOR (p. 2)

Connect the supplied antenna here.

\*1 For the USA, EXP, and AUS versions

\*2 For the EUR, FRG, HOL, and UK versions

## Function Display

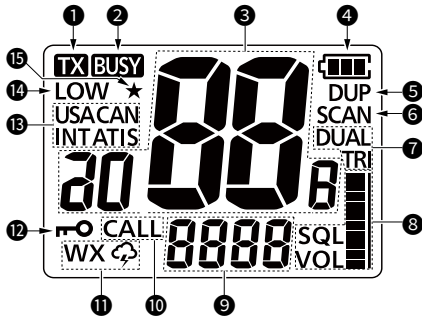

- 1 TRANSMIT INDICATOR**  
Displayed while transmitting.
  - 2 BUSY ICON**  
Displayed while receiving, or the squelch is open.
  - 3 CHANNEL NUMBER READOUT**  
Displays the selected operating channel number.
  - 4 BATTERY INDICATOR**
    - Displays the battery status.
- | Indication | Battery status    |
|------------|-------------------|
|            | Full              |
|            | Mid               |
|            | Charging required |
|            | Battery exhausted |
- 5 DUPLEX INDICATOR**  
Displayed when a Duplex channel is selected.
  - 6 SCAN INDICATOR\*1**  
Blinks while scanning. (p. 15)
  - 7 DUALWATCH/TRI-WATCH INDICATOR\*1**  
Blinks during Dualwatch or Tri-watch operation. (p. 16)

- 8 VOLUME/SQUELCH LEVEL INDICATOR**
  - Number of bars shows the volume/squelch level.
  - “SQL” blinks when adjusting the squelch level. (p. 12)
  - “VOL” blinks when adjusting the volume level.
- 9 SUB CHANNEL READOUT**
  - Displays the volume/squelch level while adjusting the level. (p. 12)
  - Displays Channel 16 during a priority scan, Dualwatch or Tri-watch. (p. 16)
  - Displays the Set mode item while in the Set mode. (p. 17)
- 10 CALL CHANNEL INDICATOR**  
Displayed when the Call channel is selected. (p. 9)
- 11 WEATHER CHANNEL ICON\*2**  
Displayed when the Weather channel is selected. (p. 10)
  - ① “WX” is displayed when the Weather Alert function is ON.
- 12 LOCK ICON**  
Displayed when the Lock function is ON.
- 13 CHANNEL GROUP INDICATOR** (p. 9)  
Displays the selected channel group, INT (International), USA, CAN (Canada), or ATIS.
  - ① The selectable channels differ, depending on the transceiver version, or the presetting.
- 14 LOW POWER INDICATOR**
  - Displayed when low power is selected.
  - Blinks when a high temperature error or low voltage is detected, and automatically switches to low power.
- 15 FAVORITE CHANNEL ICON**  
Displayed when a Favorite channel is selected. (p. 15)

\*1 Except the HOL version

\*2 For the USA, EXP, and AUS versions

## ■ Battery caution

Misuse of Li-ion batteries may result in the following hazards: smoke, fire, or the battery may rupture. Misuse can also cause damage to the battery or degradation of battery performance.

⚠ **DANGER! NEVER** solder the battery terminals, or **NEVER** modify the battery pack. This may cause heat generation, and the battery may burst, emit smoke or catch fire.

⚠ **DANGER! NEVER** place or leave battery packs in areas with temperatures above 60°C (140°F). High temperature buildup in the battery cells, such as could occur near fires or stoves, inside a sun-heated vehicle, or in direct sunlight for long periods of time may cause the battery cells to rupture or catch fire. Excessive temperatures may also degrade the battery pack's performance or shorten the battery cell's life.

⚠ **DANGER! NEVER** strike or otherwise impact the battery pack. Do not use the battery pack if it has been severely impacted or dropped, or if the pack has been subjected to heavy pressure. Battery pack damage may not be visible on the outside of the case. Even if the surface of the battery does not show cracks or any other damage, the cells inside the battery may rupture or catch fire.

⚠ **DANGER! NEVER** place battery packs near a fire. Fire or heat may cause them to rupture or explode. Dispose of used battery packs in accordance with local regulations.

⚠ **DANGER! NEVER** let fluid from inside the battery get in your eyes. This can cause blindness. Rinse your eyes with clean water, without rubbing them, and immediately go to a doctor.

⚠ **WARNING! NEVER** use deteriorated battery packs. They could cause a fire.

⚠ **WARNING! NEVER** put the battery pack in a microwave oven, high-pressure container, or in an induction heating cooker. This could cause a fire, overheating, or cause the battery cells to rupture.

⚠ **WARNING! NEVER** let fluid from inside the battery cells come in contact with your body. If it does, immediately wash with clean water.

**CAUTION: DO NOT** continue to use the battery pack if it emits an abnormal odor, heats up, or is discolored or deformed. If any of these conditions occur, contact your Icom dealer or distributor.

**CAUTION: DO NOT** expose the battery pack to rain, snow, saltwater, or any other liquids. Do not charge or use a wet pack. If the pack gets wet, be sure to wipe it with a clean dry cloth before using.

**CAUTION: DO NOT** use the battery pack out of the specified temperature range for the transceivers:

IC-M37: -20°C ~ +60°C (-4°F ~ +140°F)

IC-M37E: -15°C ~ +55°C (5°F ~ 131°F)

IC-M37E (AUS):

-10°C ~ +55°C (14°F ~ 131°F)

and the battery itself (-20°C ~ +60°C

(-4°F ~ +140°F)). Using the battery out of

its specified temperature range will reduce its performance and battery cell's life.

Please note that the specified temperature range of the battery may exceed that of the transceiver. In such cases, the transceiver may not work properly because it is out of its operating temperature range.

**CAUTION: DO NOT** leave the pack fully charged, completely discharged, or in an excessive temperature environment (above 50°C, 122°F) for an extended period of time. If the battery pack must be left unused for a long time, it must be detached from the transceiver after discharging. You may use the battery pack until the remaining capacity is about half, then keep it safely in a cool and dry place at the following temperature range:

- 20°C ~ +50°C (-4°F ~ +122°F)  
(within a month)
- 20°C ~ +40°C (-4°F ~ +104°F)  
(within three months)
- 20°C ~ +20°C (-4°F ~ +68°F)  
(within a year)

**BE SURE** to replace the battery pack with a new one approximately five years after manufacturing, even if it still holds a charge. The material inside the battery cells will become weak after a period of time, even with little use. The estimated number of times you can charge the pack is between 300 and 500. Even when the pack appears to be fully charged, the operating time of the transceiver may become short when:

- Approximately 5 years have passed since the pack was manufactured.
- The pack has been repeatedly charged.

## ■ Charging caution

⚠ **DANGER! NEVER** charge the battery pack in areas with extremely high temperatures, such as near fires or stoves, inside a sun-heated vehicle, or in direct sunlight. In such environments, the safety/protection circuit in the battery will activate, causing the battery to stop charging.

⚠ **WARNING! NEVER** charge the transceiver during a lightning storm. It may result in an electric shock, cause a fire or damage the transceiver. Always disconnect the power adapter before a storm.

⚠ **WARNING! NEVER** charge or leave the battery in the battery charger beyond the specified time for charging. If the battery is not completely charged by the specified time, stop charging and remove the battery from the battery charger. Continuing to charge the battery beyond the specified time limit may cause a fire, overheating, or the battery may rupture.

⚠ **WARNING!** Occasionally observe the battery pack condition while charging. If any abnormal condition occurs, discontinue using the battery pack.

**CAUTION: DO NOT** insert the transceiver (battery attached to the transceiver) into the charger if it is wet or soiled. This could corrode the battery charger terminals or damage the charger. The charger is not waterproof.

**CAUTION: DO NOT** charge the battery pack outside of the specified temperature range for BC-235:

IC-M37/IC-M37E (AUS):

15°C ~ 40°C (59°F ~ 104°F)

IC-M37E: 15°C ~ 35°C (59°F ~ 95°F)

Otherwise, the charging time will be longer, but the battery will not reach a full charge. While charging, at a point after the temperature goes out of the specified range, the charging will automatically stop.

## 4 BATTERY CHARGING

### ■ Battery charger

#### ◇ Supplied battery charger

Charging time: Approximately 4 hours for the BP-296

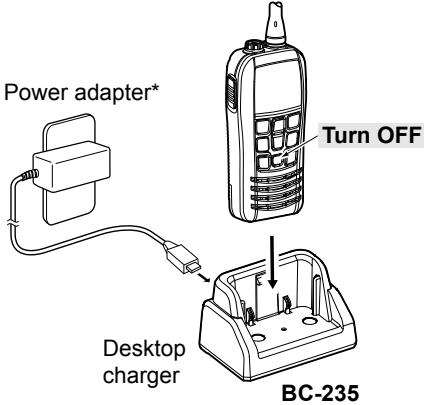

#### ◇ Optional battery charger

Charging time: Approximately 4 hours for the BP-296

**CAUTION: NEVER** connect the OPC-2416 to a power source using reverse polarity. This will ruin the battery charger. The positive (+) side is marked with a white dashed line.

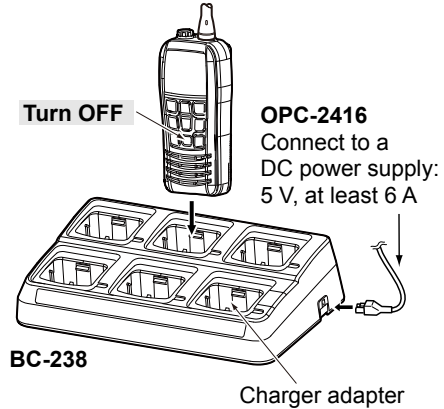

\* Not supplied, or the shape is different, depending on the transceiver version.

① “**Er**” is displayed and bars of the battery icon scroll while charging.

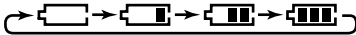

① “**F<sub>L</sub>**” is displayed when the battery has been fully charged.

#### NOTE:

- The transceiver **MUST** be turned OFF while charging. Otherwise:
  - The battery will not be charged correctly.
  - The battery life may be shortened.
- **DO NOT** transmit while charging. When you need to transmit, remove the transceiver from the charger, and then turn ON the transceiver.
- The transceiver is designed to not easily come out of the charger when the vessel is pitching and rolling. If you cannot easily remove the transceiver from the charger, tilt the transceiver forward and remove it, as shown to the right.
- If the battery pack does not properly charge when it is attached to the transceiver, remove the transceiver from the charger and insert the transceiver into the charger again.
  - ① When error is detected, the battery icon blinks, and “**Er**” and “**Er**” are displayed.

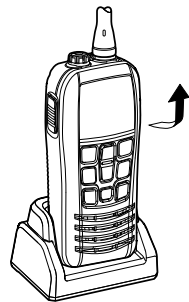



## ■ Selecting a channel

### ◇ Regular Channel

You can select a channel by pushing [▲] or [▼].

### ◇ Channel 16

Channel 16 is the distress and safety channel. It is used to establish the initial contact with a station, and for emergency communications. Channel 16 is monitored during both Dualwatch and Tri-watch. While in the standby, you must monitor Channel 16.

- Push [16/C] to select Channel 16.
  - ① To return to the previously selected channel, push [CH/WX].

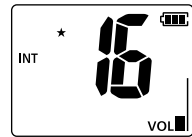

### ◇ Call channel

Each Channel Group has separate leisure-use Call channels. The Call channel is scanned during Tri-watch. The Call channels can be selected and used to store your most often used channels in each Channel Group, for quick recall.

See page 13 for details on setting the Call channel.

- Hold down [16/C] for 1 second to select the Call channel.
  - The Call channel number and "CALL" are displayed.
  - ① To return to the previously selected channel, push [CH/WX].

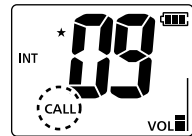

### ◇ Selecting a Channel Group

Channel Groups are preset into your transceiver. You can select a Channel Group for USA, International, Canadian, and ATIS, depending on the transceiver version.

- Hold down [U//C] (CH/WX) for 1 second to change the channel group.
  - ① The selectable channel groups may differ, depending on the transceiver version.

Version	Preset Channel Group			
	USA	INT	CAN	ATIS
USA	✓	✓	✓	
UK	✓	✓		
EUR		✓		
FRG		✓		✓
HOL		✓		✓
AUS	✓	✓		
EXP (Other)	✓	✓	✓	

**NOTE:** You cannot transmit on Channel 70.

## 5 BASIC OPERATION

### ■ Weather channels and Weather Alert (For the USA, EXP, and AUS versions)



The transceiver has 10 preset Weather channels. The transceivers are capable\* of monitoring broadcasts from the National Oceanographic and Atmospheric Administration (NOAA). The transceiver automatically detects a Weather alert tone on the selected weather channel, or while scanning.

\* When used within range of the broadcasts.

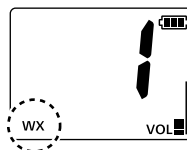
1. Push [CH/WX].
  - “WX” is displayed on the operating screen instead of the Channel Group.
2. Push [▲] or [▼] to select a Weather channel.



#### ◇ Setting the Weather Alert

1. While holding down [VOL/SQL], push [⏏] to enter the Set mode.
2. Push [VOL/SQL] to select the Weather Alert item.
  - “” is displayed.
3. Push [▲] or [▼] to turn ON the Weather Alert.
  - “” is displayed.
4. Push [16/C] to exit the Set mode.

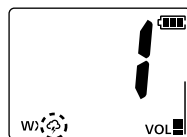

#### The Weather channel list

Channel	Frequency (MHz)	Channel	Frequency (MHz)
1	162.550	6	162.500
2	162.400	7	162.525
3	162.475	8	161.650
4	162.425	9	161.775
5	162.450	10	163.275

**NOTE:** When this function is turned ON, the currently selected weather channel is monitored, even while receiving another channel (when the Power Save function is turned ON), or during a scan.

## ■ Receiving and transmitting

**CAUTION: DO NOT** transmit without an antenna.

**NOTE:** Before using the transceiver for the first time, the battery pack must be fully charged for optimum life and operation. See Section 4 for battery charging.

1. Push [▲] or [▼] to select a channel.
  - When a signal is received, “**BUSY**” is displayed.
2. Hold down [PTT], and speak into the microphone to transmit.
  - “**TX**” is displayed while transmitting.
3. Release [PTT] to receive.

**TIP:** To maximize the readability of your transmitted signal, pause for a second after pushing [PTT] and hold the microphone 5 ~ 10 cm (2 ~ 4 inches) from your mouth, and then speak at your normal voice level.

**NOTE:**

- To conserve battery power, the Power Save function automatically turns ON when no signal is received for 5 seconds.
- The Time-out Timer function\* cuts OFF transmission after 5 minutes of continuously transmitting, to prevent prolonged transmission. 10 seconds before transmission is cut off, a beep sounds to indicate the transmission will be cut off, and “TOT” blinks. After it is cut OFF, “TOT” is displayed for 10 seconds, and you cannot transmit until it disappears.

\* This function may not be installed, depending on the transceiver version.

① Select a channel.

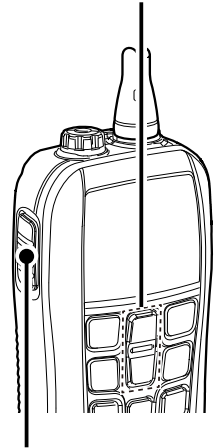

② Push to transmit.

③ Release to receive.

5

### ◆ SP Line Convert function

When the optional speaker microphone is not used, the speaker can be converted into a microphone.

- ① The speaker automatically converts into a microphone when the transceiver is floating on the water, depending on the Set mode setting. (p. 19)
- Push [VOL/SQL] while holding down [PTT] to turn the function ON or OFF.

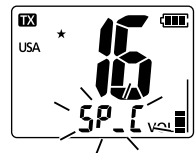

## 5 BASIC OPERATION

### ■ Adjusting the squelch level

Squelch enables the audio to be heard only while receiving a signal that is stronger than the set level. A higher level blocks weak signals, so that you can receive only stronger signals. A lower level enables you to hear weak signals.

1. Push [VOL/SQL] twice to enter the Squelch Adjustment mode.
2. Push [▲] or [▼] to adjust the squelch level, until the noise just disappears.
3. Push [VOL/SQL] once to exit the Squelch Adjustment mode.

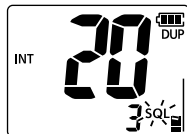

### ■ Volume Loud/Mute function

You can temporary maximize the volume level with a simple operation.

- While holding down [VOL/SQL], push [▲].
  - The volume level is set to the maximum level.
  - Push [VOL/SQL] and [▲] again to turn OFF the function.

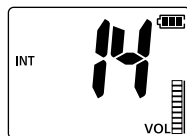

You can temporary mute the audio output with a simple operation.

- While holding down [VOL/SQL], push [▼].
  - The volume level is set to the minimum level (OFF).
  - Push [VOL/SQL] and [▼] again to turn OFF the function.

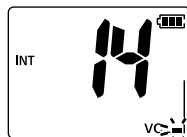

### ■ Monitor function

The monitor function opens the squelch.

- ① The monitor key action can be selected in the set mode. (p. 18)
- The monitor function is activated by holding down [MONI] for 1 second.
  - "BUSY" blinks and the squelch is opened.

### ■ AquaQuake Water Draining function

Water in the speaker grill may muffle the sound coming from the speaker. The AquaQuake Water Draining function removes water from the speaker grill by vibrating the speaker cone.

- ① The AquaQuake Water Draining function is not usable when using the optional speaker microphone.

1. Hold down both [SCAN] and [Hi/Lo] for 1 second.
  - "AQUA" is displayed.
  - A low frequency vibration sounds is heard for 10 seconds to drain the water, regardless of the volume level setting.

**CAUTION:** The low frequency vibration sounds loudly.

2. Push any key to turn OFF the function.

## ■ Setting the Call channel

By default, a Call channel is set in each Channel Group. You can set your most often-used channel as your Call channel in each Channel Group, for quick recall.

1. Hold down [16/C] for 1 second to select the Call channel.
  - “CALL” and the Call channel number is displayed.
2. Hold down [16/C] again for 3 seconds (until a long beep changes to 2 short beeps).
  - The Call channel number blinks.
3. Push [▲] or [▼] to select the channel.
4. Push [16/C] to set the selected channel as the Call channel.
  - The Call channel number stops blinking.

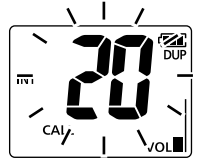
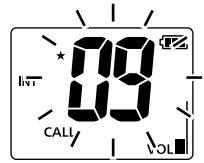

5

## ■ Power OFF Subfunction

Subfunctions can be activated by holding down a specific key when the transceiver is OFF.

① This function works even if the lock function is turned ON.

1. Turn OFF the transceiver.
2. Hold down a key to turn ON the function.

Mode	Key	Function
Light	[VOL/SQL]	Turns ON the an LCD and key backlight.
Emergency	[SCAN]	An emergency alarm sounds, and the sound gradually becomes louder. <b>CAUTION:</b> The alarm sounds loudly.
Battery Voltage	[FAV]	Displays the battery voltage. (For example: [3_60] means 3.60 V.) ① [AL] is displayed when using alkaline batteries.
Flash	[Hi/Lo]	The LCD and key backlight blink.

- The function is activated while holding down the key.
- ① The function is turned OFF after the set period has passed from releasing the key, depending on the Set mode setting. (p. 19)
- ① If you want to turn OFF the function before the set period has passed, push any key.

## ■ CH History function

The CH History function quickly selects your last-used channel.

- ① Up to 5 channels are saved in each Channel Group.
- ① The CH History is saved, even if the transceiver is turned ON or OFF.

1. Push [CH/WX] and [▼] to enter the CH History selection mode.
  - “H. 5E” blinks.
2. Push [▼] to select the registered channel.
3. Turn OFF the transceiver, and then push [⏻] while holding down [▼] to delete the CH History.

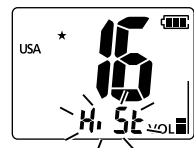

# 6

## SCAN OPERATION

You can find ongoing communication by scanning the Favorite channels. Scan is for the all transceiver versions except the HOL version.

### Before starting a scan:

- Set the channels that you want to scan as Favorite channels. (p. 15)
  - ① Only the Favorite channels are scanned.
- Set the scan type to "Priority Scan" or "Normal Scan" on the Set mode setting. (p. 18)

### Normal Scan

Sequentially searches through all Favorite channels. Channel 16 is not scanned unless it is set as a Favorite channel.

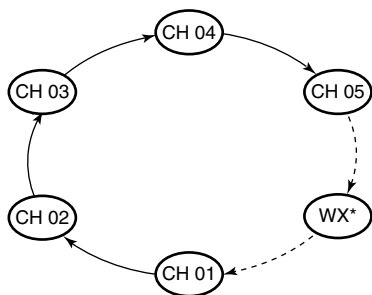

\* For the USA, EXP, and AUS versions. When the Weather Alert function is ON, the previously selected Weather channel is also scanned.

### Priority Scan

Sequentially searches through all Favorite channels, while also periodically checking Channel 16.

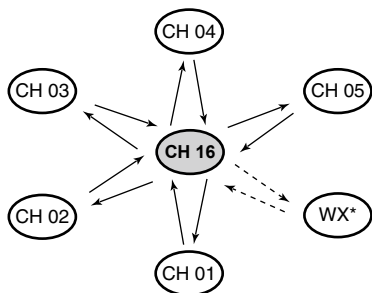

\* For the USA, EXP, and AUS versions. When the Weather Alert function is ON, the previously selected Weather channel is also scanned.

### When a signal is received:

**On Channel 16:**

The scan pauses until the signal disappears.

**On a channel other than Channel 16:**

The scan switches to Dualwatch until the signal disappears.

## Favorite channels

You can quickly recall often-used channels by setting them as Favorite channels. You can set Favorite channels in each Channel Group.

### ◇ Setting/Clearing

1. Push [▲] or [▼] to select the channel.
2. Hold down [FAV] for 1 second to set or clear as a Favorite channel.
  - The selected channel is set as a Favorite channel, and “★” is displayed.

### ◇ Selecting

- Push [FAV].
  - ① Non-Favorite channels are skipped and not displayed.

**TIP:** You can clear all Favorite channels.

① If there is no Favorite channel, all channels will be set as Favorite channels.

1. Turn OFF the transceiver.
2. While holding down [FAV], turn ON the transceiver.

## Starting a scan (Except the HOL version)

**Example:** Starting a Normal Scan.

1. Push [SCAN] to start the scan.
  - “SCAN” blinks during a Normal Scan.
  - “f5” is also displayed during a Priority Scan.
  - “BUSY” is displayed when a signal is received.
  - ① When a signal is received, the scan pauses until it disappears, or resumes after 5 seconds, depending on the Set mode setting. (p. 18)
  - ① 2 beeps sound and “f5” blinks when a signal is received on Channel 16 during a Priority scan.
2. Push [SCAN] to stop the scan.

**TIP:** In order to properly receive signals, be sure to adjust the squelch to a suitable level.

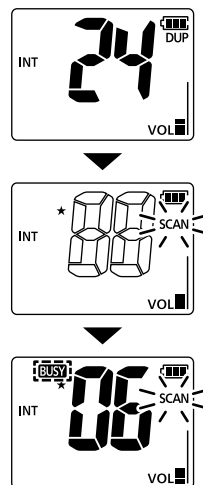

# 7

## DUALWATCH AND TRI-WATCH (Except the HOL version)

### ■ Description

Dualwatch and Tri-watch are convenient to periodically check Channel 16 while you are operating on another channel.

#### Dualwatch

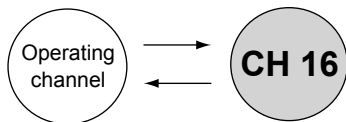

Periodically checks Channel 16 while operating on another channel.

#### Tri-watch

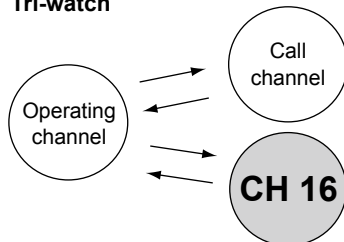

Periodically checks Channel 16 and the Call channel while operating on another channel.

#### When a signal is received:

**On Channel 16:** Dualwatch/Tri-watch pauses on Channel 16 until the signal disappears.

**On the Call channel:** Tri-watch switches to Dualwatch until the signal on the Call channel disappears.

### ■ Operation

**Example:** Operating Dualwatch on Channel 7.

1. Select Dualwatch in the Set mode setting. (p. 18)
2. Push [▲] or [▼] to select a channel.
3. Hold down [DUAL] for 1 second.
  - Dualwatch starts.
  - “DUAL” and “16” blink during Dualwatch.
  - “CALL” is displayed when a signal is received on the Call channel.
4. Push [DUAL] again to cancel Dualwatch.

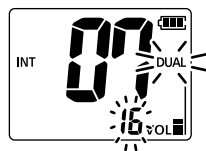
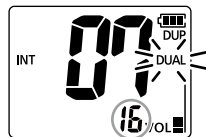
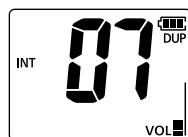



## ■ Using the Set mode

You can set seldom changed settings in the Set mode.

You can customize the transceiver settings to suit your preference and operating style.

1. While holding down [VOL/SQL], push [⏻] to enter the Set mode.
  - The “Beep” item is displayed.
  - ① When the transceiver is turned OFF:
    - Hold down [VOL/SQL], and within 1 second, push [⏻]. This will turn ON the transceiver and enter the Set mode.
2. Push [VOL/SQL], or push [▲] or [▼] while holding down [VOL/SQL] to select an item.
3. Push [▲] or [▼] to select an option.
4. Push [16/C] to exit the Set mode.

• Beep 	• WX Alert*1 	• Scan Type*2 
• Scan Timer*2 	• Auto Scan*2 	• Dual/Tri-watch*2 
• SQL Key Action 	• Backlight 	• Contrast 
• Power Save 	• CH Display*3 	• Float'n Flash 
• Float'n Flash Alarm 	• Float'n Flash Power Save 	• Low Battery Alarm 
• Sub-function Delay Timer 	• Auto SP Line Convert 	

\*1 For the USA, EXP, and AUS transceiver versions \*2 Except the HOL version

\*3 The “CH Display” item is displayed for each selectable channel group.

## ■ Set mode items

**NOTE:** The Set mode items contained in the transceiver may be different, depending on the transceiver's version or presets. Ask your dealer for details.

### **Beep “ $\text{b}\{\text{E}\}\text{P}$ ”**

Turns the Key Beep function ON or OFF.  
OFF: Turns OFF the function for silent operation.  
ON: When a key is pushed, a beep sounds.

### **WX Alert “ $\text{W}\{\text{X}\}\text{r}\{\text{t}\}$ ”**

**(For the USA, EXP, and AUS versions)**

Turns the Weather Alert function ON or OFF.  
① See page 10 for details.  
OFF: The transceiver does not detect a Weather Alert tone.  
ON: The transceiver detects the Weather Alert tone, and the “WX  $\{\text{X}\}$ ” icon blinks and a beep sounds.  
① The blinking stops when another key is pushed.

### **Scan Type “ $\text{P}\{\text{r}\}\{\text{O}\}$ ”**

**(Except the HOL version)**

Turns the Priority Scan function ON or OFF.  
OFF: The scan type is set to “Normal,” which sequentially searches all Favorite channels in the channel group.  
ON: The scan type is set to “Priority,” which sequentially searches all Favorite channels in the channel group, while also periodically checking Channel 16 (Priority channel).

### **Scan Timer “ $\text{S}\{\text{t}\}\{\text{I}\}$ ”**

**(Except the HOL version)**

Turns the Scan Resume Timer ON or OFF.  
OFF: When a signal is detected on a channel, the scan pauses until the signal disappears, and then resumes.  
ON: When a signal is detected on a channel, the scan pauses for 5 seconds, and then resumes. If the signal disappears in less than 5 seconds, the scan immediately resumes.

### **Auto Scan “ $\text{A}\{\text{u}\}\{\text{t}\}\{\text{O}\}$ ”**

**(Except the HOL version)**

Turns the Automatic Scan function ON or OFF.  
OFF: The function is OFF.  
ON: Scan automatically starts when no signal is received, or no operations are carried out for 30 seconds.

### **Dual/Tri-watch “ $\text{d}\{\text{t}\}$ ”**

**(Except the HOL version)**

Selects Dualwatch or Tri-watch.  
d- (Dual): Periodically checks Channel 16 while operating on another channel.  
t- (Tri): Periodically checks Channel 16 and the Call channel while operating on another channel.

### **SQL Key Action “ $\text{S}\{\text{Q}\}\{\text{L}\}$ ”**

The function temporarily opens the squelch.  
Pu (Push): The Monitor function is activated by holding down [VOL/SQL] for more than 1 second. The squelch opens while holding down the key.  
Ho (Hold): The Monitor function is activated by holding down [VOL/SQL] for more than 1 second. The squelch stays open until the user pushes any key.

### **Backlight “ $\text{B}\{\text{L}\}\{\text{I}\}$ ”**

Turns the Automatic Backlight function ON or OFF.  
OFF: The function is OFF.  
ON: The backlight turns ON for 5 seconds when the user pushes any key except [PTT].

### **Contrast “ $\text{C}\{\text{O}\}\{\text{N}\}$ ”**

Selects the transceiver's display contrast.  
Hi: The transceiver's display contrast is set to High.  
Lo: The transceiver's display contrast is set to Low.

### **Power Save “ $\text{P}\{\text{S}\}\{\text{A}\}$ ”**

Turns the Power Save function ON or OFF.  
OFF: The function is OFF.  
ON: The Power Save function reduces current drain by deactivating the receiver circuit of the transceiver at specified intervals.

### CH Display “**CH\_1**”/“**CH\_U**”/“**CH\_C**”

Selects the number of digits to display the channel number. You can select settings for each channel group.

3d: The channel number is displayed in 3 digits, such as “78A.”

4d: The channel number is displayed in 4 digits, such as “1078.”

### Float’n Flash “**FLAS**”

Turns the Float’n Flash function ON or OFF. You can easily retrieve the transceiver from the water.

① This function works even if the transceiver is turned OFF.

OFF: This function is OFF.

ON: The backlight, LED, or both of them send out intermittent light when the transceiver is floating on the water.

① This function is temporally OFF, and the transceiver can be operated when any key is pushed. This function is turned ON in 10 seconds after releasing the key.

### Float’n Flash Alarm “**F\_AL**”

Selects whether or not an alarm sounds while the light blinks when the transceiver is floating on the water.

① This function is usable only when the Float’n Flash is turned ON.

OFF: The alarm does not sound.

ON: The alarm sounds while the light blinks when the transceiver is floating on the water.

**CAUTION:** The alarm sounds loudly.

### Float’n Flash Power Save “**F\_PS**”

Turns the Float’n Flash Power Save function ON or OFF.



① This function is usable only when the Float’n Flash is turned ON.

OFF: This function is OFF.

ON: When the transceiver floats on the water, it enters the Float’n Flash Power Save mode to conserve battery power.

### Low Battery Alarm “**Lb\_A**”

Selects whether or not an alarm sounds when the battery is low. A beep sounds every time the battery indication is lower than a displayed value. The beep interval changes, as shown below, according to the number of bars displayed.

Option	Beep interval		
	 Battery exhausted	 Charging required	 Mid
OFF	This function is OFF.		
1	Every 30 seconds	–	–
2		Every minute	Every 2 minutes
3			

### Delay Timer Subfunction “**Sb\_t**”

Sets the Delay Timer Subfunction to 10, 30, 60 seconds, or OFF. A sub function is turned OFF after the set period of time has passed after releasing a specific key.

① When the timer is set to OFF, the sub function is turned OFF when releasing the specified key.

① See page 13 for details.

### Auto SP Line Convert “**SP\_C**”

Turns the Auto SP Line Convert function ON or OFF.

① The speaker is converted into a microphone by pushing [VOL/SQL] while holding down [PTT], regardless of this setting. (p. 11)

OFF: This function is OFF.

ON: Automatically converts the speaker into a microphone, when the transceiver is floating on the water.

# ATIS CODE

## (For only the HOL and FRG versions)

The Automatic Transmitter Identification System (ATIS) ID consists of 10 digits. You can set and confirm the ID as shown below.

**NOTE:** You can enter this initial code ONLY ONCE. After entry, only your dealer or distributor can change it. If your ATIS code has already been entered, this entry is not necessary.

### ◇ Setting the ATIS code

1. Turn OFF the power.
2. While holding down [16/C], push [P].
  - Enters to the ATIS Code Setting mode.
3. Push [▲] or [▼] to select the number for the first digit of the ATIS code.
4. Push [CH/WX] to select the next digit, and then push [▲] or [▼] to select a number.
  - Pushing [VOL/SQL] selects the previous digit.
5. After the 10th digit has been input, push [Hi/Lo] to store the code.
  - The code number stops blinking.
  - Push [16/C] to return to the normal operating mode.

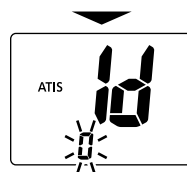

### ◇ ATIS code confirmation

(Can be performed only when the ATIS code has been programmed.)

1. Turn OFF the power.
2. While holding down [16/C], push [P] to enter the ATIS code confirmation mode.
  - The stored code number is displayed.
  - Push [CH] to select the next digit, push [VOL/SQL] to select the previous digit.
3. Push [16/C] to exit the ATIS Confirmation mode.



# SPECIFICATIONS AND OPTIONS 10

## ■ Specifications

① All stated specifications are subject to change without notice or obligation.

① Measurements made without an antenna.

General		IC-M37	IC-M37E	IC-M37E (AUS)
Frequency coverage	TX	156.025 ~ 157.425 MHz	156.000 ~ 161.450 MHz	156.025 ~ 157.425 MHz
	RX	156.050 ~ 163.275 MHz	156.000 ~ 163.425 MHz	156.300 ~ 162.000 MHz
Type of emission		16K0G3E (FM)		
Antenna impedance		50 Ω nominal		
Input impedance (MIC)		2 kΩ		
Output impedance (audio)	External	4 Ω		
	Internal	8 Ω		
Operating temperature range		-20°C ~ +60°C, -4°F ~ +140°F	-15°C ~ +55°C, 5°F ~ 131°F	-10°C ~ +55°C, 14°F ~ 131°F
Power supply voltage		Negative ground: 3.7 V DC nominal		
Current drain (at 3.7 V DC) (approximate)	Maximum audio	External speaker: 0.2 A Internal speaker: 0.4 A		
	TX high	6 W: 2.75 A 1 W: 1.0 A		5 W: 2.6 A 1 W: 1.0 A
Dimensions (projections not included)		59.7 (W) × 140.5 (H) × 38.7 (D) mm 2.4 (W) × 5.5 (H) × 1.5 (D) in		
Weight (approximate)		293 g, 10.3 oz (including battery pack, antenna, and belt clip)		

Transmitter		IC-M37	IC-M37E	IC-M37E (AUS)
Rated output power		6 W or 1 W		5 W or 1 W
Modulation		Variable reactance frequency modulation		
Maximum frequency deviation		±5 kHz		
Frequency error		±10 ppm	±1.5 kHz	±10 ppm
Spurious emissions		-68 dBc (typical)	0.25 μW	0.25 μW (typical)
Adjacent channel power		70 dB		
Audio harmonic distortion (at 60% Deviation)		10%		
Residual modulation		40 dB		
Audio frequency response		+1 dB ~ -3 dB of 6 dB octave from 300 Hz ~ 3000 Hz		

Receiver		IC-M37	IC-M37E	IC-M37E (AUS)
Sensitivity (typical)		0.25 μV at 12 dB SINAD	-4 dBμ at 20 dB SINAD	
Squelch sensitivity (typical) (at threshold)		0.25 μV	-5 dBμ	
Audio output power (at 10% distortion)	External (with 4 Ω)	0.3 W (typical)	0.2 W	
	Internal (with 8 Ω)	0.7 W (typical)		

# 10 SPECIFICATIONS AND OPTIONS

## ■ Specifications

Receiver	IC-M37	IC-M37E	IC-M37E (AUS)
Adjacent channel selectivity	70 dB (typical)	70 dB	65 dB
Spurious response	70 dB (typical)	70 dB	65 dB
Intermodulation	70 dB (typical)	68 dB	65 dB
Hum and noise	40 dB		
Audio frequency response	+1 dB ~ -3 dB of -6 dB octave from 300 Hz ~ 3000 Hz		

## ■ Options

### ◇ Battery pack/Battery case

#### • **BP-296** LI-ION BATTERY PACK

Voltage: 3.6 V

Capacity: 2200 mAh (minimum),  
2350 mAh (typical)

Battery life: Approximately 12 hours\*

\* When the Power Save function is ON,  
and the operating periods are calculated  
under the following conditions:

TX : RX : standby = 5 : 5 : 90

#### • **BP-297** BATTERY CASE

Battery case for 3 × AAA (LR03) alkaline  
batteries.

Some options may not be available in some  
countries. Please ask your dealer for details.

### ◇ Charger

#### • **BC-235** DESKTOP CHARGER

**+BC-217** AC ADAPTER

To rapidly charge a battery pack.

#### • **BC-238** MULTI CHARGER

**+OPC-2416** DC POWER CABLE

To rapidly charge a battery pack.

① The AD-138 CHARGER ADAPTERS are installed.

### ◇ Others

#### • **FA-SC59V** ANTENNA

#### • **MB-133** BELT CLIP

#### • **HM-213** SPEAKER MICROPHONE

Full sized waterproof speaker

microphone including alligator type clip to  
attach to your shirt or collar, and so on.

The HM-213 meets IP57 requirements for  
dust protection and waterproof protection.

## ■ Using the BP-297

When using the optional BP-297 battery case, install 3 × AAA (LR03) size Alkaline batteries.

### CAUTION:

- **NEVER** incinerate used battery cells since internal battery gas may cause them to rupture.
- **NEVER** expose a detached battery case to water. If the battery case gets wet, be sure to wipe it dry before using it.
- **NEVER** use batteries whose insulated cover is damaged.
- **NEVER** insert the transceiver into the charger, and charge it when the optional battery case is attached.

### NOTE:

- When installing the batteries, make sure they are all the same brand, type and capacity. Also, do not mix new and old batteries together.
- Keep the battery terminals clean. It's a good idea to occasionally clean them.
- The transceiver may sink when the optional battery case is attached. (Depends on the weight of the installed batteries.)
- When using the optional battery case, the output power level is fixed at Low power.

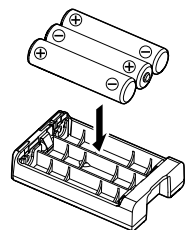

## ■ Using the HM-213

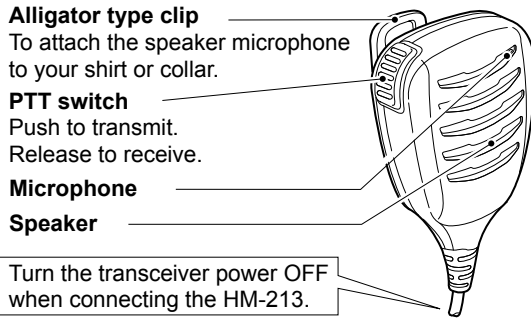

**NOTE:**

- **NEVER** immerse the connector in water. If the connector becomes wet, **BE SURE** to dry it before attaching to the transceiver.
- The microphone element is located at the top of the speaker microphone, as shown in the illustration above. To maximize the readability of your transmitted audio, hold the microphone approximately 5 ~ 10 cm (2 ~ 4 inches) from your mouth, and then speak at your normal voice level.

## ◇ Attaching the HM-213

1. Turn OFF the power.
2. Insert the speaker microphone connector into the [SP/MIC] connector and securely screw it, as shown below.
  - ① Be careful not to cross-thread the connection.

**CAUTION:** Attach the speaker microphone's connector securely to prevent accidental loss, or water intrusion into the connector.

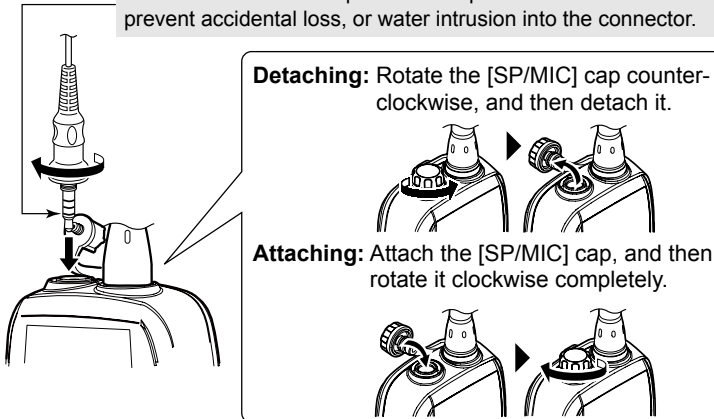

**NOTE:** **KEEP** the transceiver's [SP/MIC] cap attached when the speaker microphone is not used. If the cover is not attached, water will get into the transceiver. Moreover, the terminals (pins) will become rusty, or the transceiver will function abnormally if the connector gets wet.

# 11 VHF MARINE CHANNEL LIST

## ■ For IC-M37 (USA and EXP) and IC-M37E (AUS)

**NOTE:** When the "CH Display" is set to "4d" in the Set mode, the channel number is displayed in 4 digits. See page 19 for details. (Example: Channel 78A is displayed as "1078," channel 78b is displayed as "2078.")

Channel Number			Frequency (MHz)	
USA	INT	CAN	Transmit	Receive
	01	01	156.050	160.650
01A	01A*4		156.050	156.050
	02	02	156.100	160.700
	03	03	156.150	160.750
	04		156.200	160.800
		04A	156.200	156.200
	05A*4		156.250	160.850
05A		05A	156.250	156.250
06	06	06	156.300	156.300
	07		156.350	160.950
07A	07A*4	07A	156.350	156.350
08	08	08	156.400	156.400
09	09	09	156.450	156.450
10	10	10	156.500	156.500
11	11	11	156.550	156.550
12	12	12	156.600	156.600
13*1	13	13*1	156.650	156.650
14	14	14	156.700	156.700
15*3	15*2	15*1	156.750	156.750
16	16	16	156.800	156.800
17*1	17	17*1	156.850	156.850
	18		156.900	161.500
18A	18A*4	18A	156.900	156.900
	19		156.950	161.550
19A	19A	19A	156.950	156.950
	19b		RX only	161.550
20	20	20*1	157.000	161.600
20A	20A		157.000	157.000
	20b		RX only	161.600
	21		157.050	161.650
21A	21A*4	21A	157.050	157.050
		21b	RX only	161.650
	22		157.100	161.700
22A	22A*4	22A	157.100	157.100
	23	23	157.150	161.750
23A	23A*4		157.150	157.150
		23b	RX only	161.750
24	24*5	24	157.200	161.800
25	25*5	25	157.250	161.850
		25b	RX only	161.850
26	26*5	26	157.300	161.900
27	27	27	157.350	161.950
	27A*4		157.350	157.350
28	28	28	157.400	162.000
	28A*4		157.400	157.400
		28b	RX only	162.000
	60	60	156.025	160.625

Channel Number			Frequency (MHz)	
USA	INT	CAN	Transmit	Receive
	61		156.075	160.675
		61A	156.075	156.075
	62		156.125	160.725
		62A	156.125	156.125
	63		156.175	160.775
63A	63A*4	63A	156.175	156.175
	64	64	156.225	160.825
		64A	156.225	156.225
	65		156.275	160.875
65A	65A*4	65A*1	156.275	156.275
	66		156.325	160.925
66A	66A*4	66A*1	156.325	156.325
67*1	67	67	156.375	156.375
68	68	68	156.425	156.425
69	69	69	156.475	156.475
71	71	71	156.575	156.575
72	72	72	156.625	156.625
73	73	73	156.675	156.675
74	74	74	156.725	156.725
	75*2	75*1	156.775	156.775
	76*2	76*1	156.825	156.825
77*1	77	77*1	156.875	156.875
	78		156.925	161.525
78A	78A	78A	156.925	156.925
	78b		RX only	161.525
	79		156.975	161.575
79A	79A	79A	156.975	156.975
	79b		RX only	161.575
	80		157.025	161.625
80A	80A*4	80A	157.025	157.025
	81		157.075	161.675
81A	81A*4	81A	157.075	157.075
	82		157.125	161.725
82A	82A*4	82A	157.125	157.125
	83		157.175	161.775
83A	83A*4	83A	157.175	157.175
		83b	RX only	161.775
84	84*5	84	157.225	161.825
85	85*5	85	157.275	161.875
86	86*5	86	157.325	161.925
87	87	87	157.375	157.375
88	88	88	157.425	157.425

\*1 Low power only

\*2 Low power only except the AUS version

\*3 RX only

\*4 For only the USA and EXP versions

\*5 For only the AUS versions

**NOTE:** Simplex channels, 21, 23, 81, 82 and 83 CANNOT be lawfully used by the general public in USA waters.



## ■ For IC-M37E (Except AUS)

**NOTE:** When the "CH Display" is set to "4d" in the Set mode, the channel number is displayed in 4 digits. See page 19 for details. (Example: Channel 78A is displayed as "1078," channel 78b is displayed as "2078.")

### ◇ International channels

CH	Frequency (MHz)		CH	Frequency (MHz)		CH	Frequency (MHz)		CH	Frequency (MHz)	
	Transmit	Receive		Transmit	Receive		Transmit	Receive		Transmit	Receive
01	156.050	160.650	18	156.900	161.500	60	156.025	160.625	78	156.928	161.525
02	156.100	160.700	19	156.950	161.550	61	156.075	160.675	1078	156.925	161.525
03	156.150	160.750	1019	156.950	161.550	62	156.125	160.725	2078	RX only	161.525
04	156.200	160.800	2019	RX only	161.550	63	156.175	160.775	79	156.975	161.575
05	156.250	160.850	20	157.000	161.600	64	156.225	160.825	1079	156.975	161.575
06	156.300	160.900	1020	157.000	161.600	65	156.275	160.825	2079	RX only	161.575
07	156.350	160.950	2020	RX only	161.600	66	156.325	160.925	80	157.025	161.625
08	156.400	161.000	21	157.050	161.650	67	156.375	160.975	81	157.075	161.675
09	156.450	161.050	22	157.100	161.700	68	156.425	161.025	82	157.125	161.725
10	156.500	161.100	23	157.150	161.750	69	156.475	161.075	83	157.175	161.775
11	156.550	161.150	24	157.200	161.800	71	156.575	161.175	84	157.225	161.825
12	156.600	161.200	25	157.250	161.850	72	156.625	161.225	85	157.275	161.875
13	156.650	161.250	26	157.300	161.900	73	156.675	161.275	86	157.325	161.925
14	156.700	161.300	27	157.350	161.950	74	156.725	161.325	87	157.375	161.975
15*1	156.750	161.350	28	157.400	162.000	75*1	156.775	161.375	88	157.425	161.975
16	156.800	161.400	31*1*3	157.050	162.150	76*1	156.825	161.425	P4*2	161.425	161.425
17*1	156.850	161.450	37A*2	157.850	162.850	77	156.875	161.475			

\*1 Low power only

\*2 UK Marina Channels:

M1=37A (157.850 MHz) for the UK and HOL versions, M2=P4 (161.425 MHz) for only the UK version

\*3 For only the HOL version

### ◇ USA channels

CH	Frequency (MHz)		CH	Frequency (MHz)		CH	Frequency (MHz)		CH	Frequency (MHz)	
	Transmit	Receive		Transmit	Receive		Transmit	Receive		Transmit	Receive
01A	156.050	160.650	17*1	156.850	161.450	37A*3	157.850	161.450	79A	156.975	161.575
05A	156.250	160.850	18A	156.900	161.500	63A	156.175	160.775	80A	157.025	161.625
06	156.300	160.900	19A	156.950	161.550	65A	156.275	160.875	81A	157.075	161.675
07A	156.350	160.950	20	157.000	161.600	66A	156.325	160.925	82A	157.125	161.725
08	156.400	161.000	20A	157.000	161.600	67*1	156.375	160.975	83A	157.175	161.775
09	156.450	161.050	21A	157.050	161.650	68	156.425	161.025	84	157.225	161.825
10	156.500	161.100	22A	157.100	161.700	69	156.475	161.075	85	157.275	161.875
11	156.550	161.150	23A	157.150	161.750	71	156.575	161.175	86	157.325	161.925
12	156.600	161.200	24	157.200	161.800	72	156.625	161.225	87	157.375	161.975
13*1	156.650	161.250	25	157.250	161.850	73	156.675	161.275	88	157.425	162.025
14	156.700	161.300	26	157.300	161.900	74	156.725	161.325	P4*3	161.425	161.425
15*2	156.750	161.350	27	157.350	161.950	77*1	156.875	161.475			
16	156.800	161.400	28	157.400	162.000	78A	156.925	161.525			

\*1 Low power only

\*2 RX only

\*3 UK Marina Channels:

M1=37A (157.850 MHz) for the UK and HOL versions, M2=P4 (161.425 MHz) for only the UK version

**NOTE:** Simplex channels, 21, 23, 81, 82 and 83 CANNOT be lawfully used by the general public in USA waters.

# 12 TROUBLESHOOTING

---

## **The transceiver does not turn ON.**

- The battery is exhausted.  
→ Recharge the battery pack. (p. 8)
- The battery pack is not correctly attached.  
→ Correctly reattach the battery pack. (p. 3)

## **Little or no sound comes from the speaker.**

- Squelch level is set too high.  
→ Adjust the squelch level. (p. 12)
- Volume level is set too low.  
→ Adjust the volume level.
- The speaker has been exposed to water.  
→ Use the AquaQuake Water Draining function to remove water from the speaker grill.  
(p. 12)

## **You cannot transmit, or cannot select high power.**

- Some channels are set for low power or receive only by regulations.  
→ Change channels. (p. 9)
- The output power is set to low.  
→ Push [Hi/Lo] to select high power. (p. 4)

## **Scan does not start.**

- More than 2 favorite channels are not set.  
→ Set the Favorite channels. (p. 15)

## **No beep sounds.**

- The Key Beep function is OFF.  
→ Turn ON the Key Beep function. (p. 18)

## **The keypad does not work.**

- The keypad is locked.  
→ Hold down [↔] for 1 second to lock or unlock the keypad. (p. 4)

- A**
- AD-138 ..... 22
  - Antenna ..... 2
  - AquaQuake ..... 12
  - ATIS
    - ATIS code ..... 20
  - Auto Scan ..... 18
  - Auto SP Line Convert.. 19
- B**
- Backlight ..... 18
  - Battery case ..... 22
  - Battery caution ..... 6
  - Battery charger ..... 8
  - Battery pack ..... 3, 22
  - BC-217 ..... 22
  - BC-235 ..... 22
  - BC-238 ..... 22
  - Beep ..... 18
  - Belt clip ..... 2
  - BP-296
    - Battery life ..... 22
    - Charging time ..... 8
  - BP-297 ..... 22
  - Using ..... 22
- C**
- Call channel
    - Selecting ..... 9
    - Setting ..... 13
  - Channel
    - Group ..... 9
    - Selecting ..... 9
  - Channel 16
    - Selecting ..... 9
  - Charger ..... 22
  - Charging caution ..... 7
  - CH Display ..... 19
  - CH History function ..... 13
  - Contrast ..... 18
- D**
- Delay Timer Subfunction
    - ..... 19
  - Dual/Tri-watch ..... 18
    - Operation ..... 16
  - Dualwatch ..... 16
- F**
- Favorite channels
    - Clearing ..... 15
    - Selecting ..... 15
    - Setting ..... 15
  - Float'n Flash ..... 19
  - Float'n Flash Alarm ..... 19
  - Float'n Flash Power Save
    - ..... 19
  - Front panel ..... 4
  - Function display ..... 5
- H**
- HM-213
    - Attaching ..... 23
    - Using ..... 23
- L**
- Low Battery Alarm ..... 19
- M**
- Monitor function ..... 12
- O**
- OPC-2416 ..... 8, 22
  - Options ..... 22
- P**
- Panel description ..... 4
  - Power OFF Subfunction
    - ..... 13
    - Battery Voltage ..... 13
    - Emergency ..... 13
    - Flash ..... 13
    - Light ..... 13
  - Power Save ..... 18
- R**
- Receiving ..... 11
- S**
- Scan
    - Normal ..... 14
    - Priority ..... 14
    - Starting ..... 15
  - Scan Timer ..... 18
  - Scan Type ..... 18
  - Set mode
    - Items ..... 18
    - Using ..... 17
  - Side panel ..... 4
  - Specifications ..... 21
  - SP Line Convert function
    - ..... 11
  - SQL Key Action ..... 18
  - Squelch level ..... 12
- T**
- Top panel ..... 4
  - Transmitting ..... 11
  - Tri-watch ..... 16
- V**
- Volume
    - Loud ..... 12
    - Mute ..... 12
- W**
- Weather Alert ..... 10
    - Setting ..... 10
  - Weather channels ..... 10
  - WX Alert ..... 18

**Count on us!**

